

\* | 159 kW (213 HP) @ 1800 rpm

▲ | 30000 - 30900 kg

📏 | 0.80 - 1.75 m<sup>3</sup>

\* | 210 kW (281 HP) @ 1800 rpm

▲ | 34900 - 36000 kg

📏 | 1.20 - 2.01 m<sup>3</sup>



## DX300LC-3 / DX340LC-3 | Crawler Excavator



# DX300LC-3

# DX340LC-3



Take a tour	pages 4 - 5
Performance	pages 6 - 7
Comfort	pages 8 - 9
Control	pages 10 - 11
Reliability	pages 12 - 13
Maintenance	pages 14 - 15
Technical specifications	pages 16 - 17
Dimensions and working range	pages 18 - 19
Lifting capacities	pages 20 - 22
Equipment	page 23

# PROFIT FROM MORE PRODUCTIVITY & DURABILITY



## DOES YOUR MACHINE MATCH YOUR LONG-TERM NEEDS?

The new DX300LC-3 and DX340LC-3 are strong and robust enough to tackle your most demanding jobs, yet kind to the environment and your pocket. Keep profits up and costs down with a range of new features such as:

- A **new** generation Stage IIIB-compliant **engine**. Benefit from strong, responsive **power** with **reduced fuel consumption** and emissions
- **Top quality materials** and components. Count on long-term reliability and maximum uptime
- A brand new fully-featured, ergonomically designed **ROPS cab**. Work in top-class **comfort** with excellent all-round **visibility**
- The ultimate combination of **strength, stability** and **versatility**. A real return on your investment

# TAKE A TOUR

Reinforced castings and forged steel pivot points

Large, heavy-duty boom and arm cylinders for smooth, powerful operation

Reinforced heavy-duty arm and boom with new boom floating system

New work lights with improved illumination (standard: 2 front frame, 4 front & 2 rear cab-mounted, 2 boom mounted and 1 rear side)

All-round visibility with better view through the rear and right windows

Massive maximum bucket and arm digging forces of  
20.0 and 17.0 ton - DX300LC-3  
25.9 and 23.3 ton - DX340LC-3

## EXPERT CONTROL

- Joystick and switches integrated in armrest for precise operation. All switches grouped together and ergonomically positioned to the right
- Jog shuttle switch to control various machine functions
- 4 working modes for maximum efficiency
- Proportional auxiliary flow to operate attachments smoothly and precisely
- New, user-friendly 7" TFT LCD colour monitor with full access to machine settings and maintenance data
- Rear camera and large side mirrors
- Straight travel pedal (optional)

Reliable and well protected hydraulic, electric and lubrication routings with simple, optimised layout

#### COMFORTABLE WORKSPACE

- Spacious, newly designed, pressurised ROPS cab with low noise and vibration levels
- Fully adjustable heated air suspension seat as standard
- Large sun roof for extra overhead visibility
- Air conditioning with climate control
- Extra-large door for easy access

Best-in-class Turbo III and air filter for maximum fuel efficiency

#### MAXIMUM EFFICIENCY

- New powerful DOOSAN DL08K "Common Rail", Stage IIIB compliant engine
- e-EPOS System (Electronic Power Optimising System) and hydraulic power boost function for optimised combustion and minimised emissions
- Efficient conversion of engine output into hydraulic performance for better fuel efficiency and lower costs
- New electro-hydraulic system (DX340LC-3) offering more smoothness and improved productivity

#### EASY MAINTENANCE

- Easy access to all maintenance components
- Radiator and oil cooler are separate and each has its own fan for better cooling and easy maintenance
- Maintenance data available directly from control panel
- Fuel pre-filter with water separator
- PC access for maintenance and repairs
- Self-diagnosis function
- Reliable Doosan parts

#### SOLID STRENGTH

- Heavy-duty X-shaped undercarriage with integrated track spring and idler plus durable box section track frame
- Two guards per track frame available as an option to further protect from derailment
- Resilient chain for 34.0 ton class reliability
- Undercarriage: 3.00 to 3.20 m (DX300LC-3) – 3.00 to 3.28 m (DX340LC-3)
- Increased drawbar pull of 29.7 ton (DX300LC-3) – 32.2 ton (DX340LC-3)

DX340LC-3

# Improved productivity and fuel efficiency

## ■ Expect the best return on your investment

The DX300LC-3 and DX340LC-3 take even the heaviest tasks in their stride with efficient, dependable performance that saves you time and money. Increased digging power, lifting capacities and traction force combine for performance you can rely on day after day. Improved fuel efficiency means you can keep costs down and reduce the environmental impact.



## 6 ASSETS TO YOUR BENEFIT!

- Power: DX300LC-3: 159 kW (213 HP) – DX340LC-3: 210 kW (281 HP) at 1800 rpm
- Stability: 34.0 ton class heavy-duty undercarriage – DX300LC-3: 3.00 to 3.20 m – DX340LC-3: 3.00 to 3.28 m wide
- Productivity: side lifting capacity at 6 m reach and 3 m height: DX300LC-3: 7.5 ton – DX340LC-3: 9.5 ton
- Excavation: max. bucket digging force: DX300LC-3: 20.0 ton – DX340LC-3: 25.9 ton
- Traction: max. drawbar pull DX300LC-3: 29.7 ton – DX340LC-3: 32.2 ton
- Outstanding swing torque DX300LC-3: 12137 kgf/m – DX340LC-3: 13511 kgf/m



## EFFICIENT MANAGEMENT OF FUEL AND HYDRAULICS

### “Common Rail” Doosan DL08K engine

The heart of the DX300LC-3 and DX340LC-3 is the “Common Rail” DOOSAN DL08K engine, carefully designed with common rail injection and 4 valves per cylinder. The engine delivers 213 HP (159 kW / 216 PS) – DX300LC-3 and 210 kW (281 HP / 285 PS) – DX340LC-3 at only 1800 rpm. Powerful torque allows efficient use of the hydraulic system and faster working cycles.

Already known for its outstanding reliability, the DOOSAN DL08K 6 cylinder engine has been optimised for the DX300LC-3 and DX340LC-3 and is now compliant with the Stage IIIB European regulations using EGR (Exhaust Gas Recirculation) and DPF (Diesel Particulate Filter). In combination with the e-EPOS electronic control system, it offers the ultimate in power delivery and fuel economy.

## ADVANCED TECHNOLOGY FOR OPTIMUM POWER MANAGEMENT

### e-EPOS system (Electronic Power Optimising System)

If the engine is the heart of the DX300LC-3, the e-EPOS is its brain. It provides a perfectly synchronised communication link between the engine’s ECU (Electronic Control Unit) and the hydraulic system. A CAN (Controller Area Network) system enables a constant flow of information between the engine and hydraulic system, ensuring power is delivered exactly as needed.

### Simple and efficient

- Choice between 4 power modes and 4 working modes guarantees optimum performance in all conditions
- Proportional auxiliary control for attachments
- Electronic control of fuel consumption optimises efficiency
- Auto-idle function enables fuel saving
- Regulation and precise control of the flow rate required by the work group
- Self-diagnosis function allows technical problems to be resolved quickly and efficiently

### Quick and efficient

The main hydraulic pumps have an increased capacity, reducing cycle times for heightened productivity. A high capacity gear pump improves pilot line efficiency.

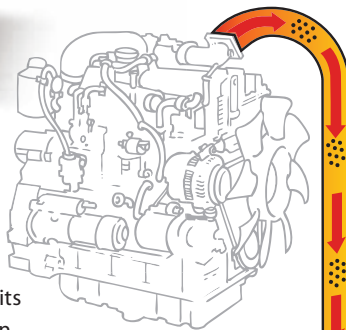

### EGR with DPF

EGR, which requires enhanced cooling capacity, reduces NOx by recirculating exhaust back into the engine. This dilutes the amount of oxygen in the combustion chamber and lowers the combustion peak temperature.

Exhaust

Exhaust with higher PM concentration goes in.

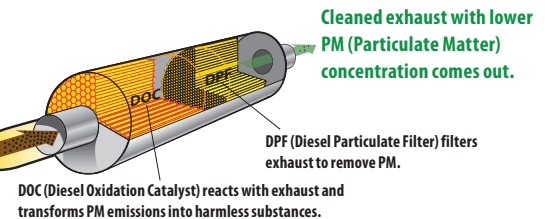

- Operational memory provides a graphic display of the machine status
- Maintenance and oil change intervals can be displayed
- The DX340LC-3 is equipped with a special new electro-hydraulic system consisting of a closed center main control valve and electronic control of pump pressure. This provides more smoothness and controllability for better operator comfort and improved overall productivity.

### Smooth and fast

The swing drive minimises shocks during rotation while making increased torque available to ensure rapid cycles.

### Separate radiator and oil cooler

The radiator and oil cooler have been separated. This reduces noise as well as improving cooling efficiency and decreasing fuel consumption and power demand.



# The ideal workspace – designed around you

The DX300LC-3 and DX340LC-3 are designed to provide you with the best possible working conditions. The sophisticated pressurised ROPS cab is ISO-certified for your safety. Its spacious interior offers a fully adjustable, heated air suspension seat. Comfortably seated, you have easy access to several storage compartments and a clear all-round view of the worksite. Noise and vibration levels have been reduced while air conditioning and automatic climate control allow you to keep working for hours on end without feeling tired.



## Heated air suspension seat (standard)

As well as being adjustable and offering lumbar support, the seat has an air suspension system to reduce vibrations. It also features a button to activate the seat heating system. A storage box has been placed under the seat for extra convenience.



## Storage space

Plenty of storage space means you can keep all your personal belongings within reach. The new cab contains 7 storage spaces including one hot/cool box (linked to the HVAC system).



## Air conditioning with climate control

The electronically controlled air conditioning system features 5 different operating modes allowing the operator to adjust the airflow to suit conditions. A recirculated air function is also available.



## MP3/USB radio and USB port

A USB port (standard) allows connection of an MP3 player (MP3/USB radio with CD player optional).





## ERGONOMIC OPERATOR ENVIRONMENT

### Feel the comfort of a seat that fits you perfectly:

Using a dual positioning cursor, you can slide the seat back from the joysticks for the best working position. You can also slide the entire seat assembly to adjust the reach to the control pedals to your leg length.

- ① Large sun roof
- ② Sun visor
- ③ Straight ergonomic pedals
- ④ Flat, spacious, easy-to-clean floor
- ⑤ Upper front window is strut-assisted for easy, reliable adjustment and integrates a sun shade
- ⑥ Joysticks and switches are integrated in adjustable control consoles
- ⑦ Separate seat height adjustment lever and cushion tilting function
- ⑧ Storage compartment for sunglasses
- ⑨ Hot/cool box
- ⑩ Photo sensor detects radiant energy of the sun and adjusts temperature automatically

### Cabsus mount

The cab features a new suspension system (CabSus mount) that combines high vibration dampening with outstanding protection against impact. The system absorbs shocks and vibrations much more effectively than a conventional viscous suspension system.



# Precision control for higher output

Doosan's unique new jog shuttle switch gives you easy, precise control over all machine functions. Proportional auxiliary flow means that the excavator's huge power is matched by smooth, confident manoeuvres. Using highly sensitive joysticks and clear controls positioned for convenient access, you are able to work safely and confidently with minimum effort. Even the switches have been ergonomically placed on the right and positioned according to the frequency with which they are used. The highest standards of efficiency are just a finger's reach away.



## Jog shuttle control switch

- Power mode and Work mode
- Auto-idle / Buzzer Stop
- Adjustments of rpm, hydraulic flow and pressure for attachments
- Rear view camera
- Multimedia: - video: AVI (DivX®), MP4, WMV  
- audio: MP3
- Menu change or selection

## Colour LCD monitor panel

The upgraded 7" TFT LCD panel is suitable for day and night work and has been relocated within the operator's line of sight. The monitor is user-friendly and gives full access to machine settings and maintenance data. Any abnormality is clearly displayed on the screen, allowing you to work safely and confidently with an accurate overview of all conditions. All functions are totally controllable, directly via the screen or using the Jog shuttle switch.



## 4 Work modes to suit your application

- 1-way mode and 2-way mode
- Digging mode and lifting mode

## 4 Power modes for maximum efficiency

- Power plus mode: uses 100 % engine power
- Power mode: uses 95 % engine power
- Standard mode: uses 92 % engine power
- Economy mode: uses 83 % engine power

## Gauges

- Engine coolant and hydraulic oil temperatures
- Fuel level
- Eco symbol: changes colour when operating conditions change (idle, normal or loading)
- Eco gauge: shows the average fuel efficiency for 1 minute of operation
- Warning symbols



4 Work modes



4 Power modes



Auto-idle

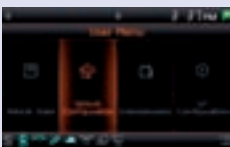

User menu

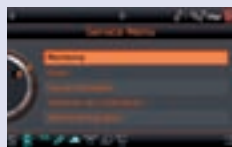

Service menu

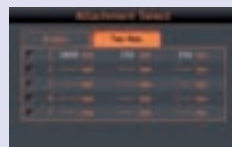

Attachment presets

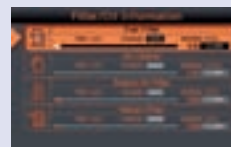

Filter/oil information

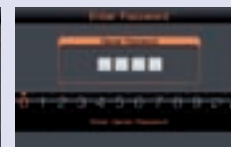

Anti-theft protection

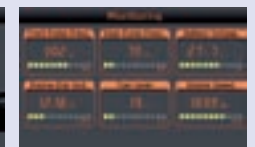

Monitoring

## Your safety – our biggest concern

- A rear view camera shows you a clear view of what's happening behind the machine. A side view camera is also available as an option for jobs requiring extra safety measures
- Cab and boom lights are fitted as standard, greatly enhancing safety on night-time jobs
- Large side mirrors improve all-round visibility (ISO compliant)

Other standard safety features include: automatic overheating prevention, low oil pressure sensor, engine emergency cut-off switch, auxiliary mode switch (to stop the pump if the control system malfunctions), overload warning device. An optional travel/swing alarm is also available.

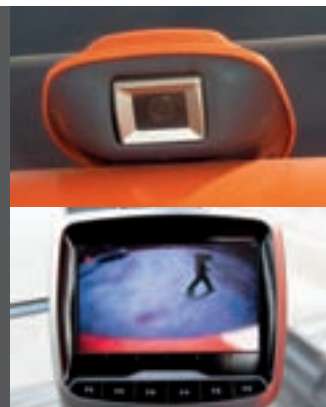



### Simple operation

- “Short stroke” joysticks enable easy, precise control of all operations
- A thumb wheel switch and buttons on the joysticks allow proportional control of attachments such as grabs, crushers and grapples
- A straight travel pedal can be installed to facilitate operation when moving in a straight line



### Dynamic power management

- Automatic travel speed function
- Activation of the power boost control system increases digging power by 10 %
- A one-touch deceleration button immediately reduces engine speed to low or idle
- Auto-idling starts after 4 seconds at low rpm. This decreases fuel consumption and reduces noise levels in the cab
- Jog shuttle dial for engine rpm

### Floating boom function

- The intelligent floating boom mode allows the boom to move up and down freely when external force is applied.
- The breaker mode restricts the boom to downward movement only. This means that the breaker can be operated using only the weight of the work group on the front, without additional force. The breaker remains in constant contact with the object. The result is reduced shock and vibration and longer breaker service life.
- During truck loading, the lowering of the boom can be controlled without hydraulic pump flow discharge. This increases productivity and fuel efficiency.

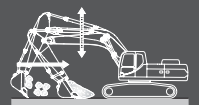

# Quality that never lets you down

## ■ Designed for long-term heavy duty

In your profession you need equipment you can depend on. At DOOSAN we use highly specialised design and analysis tools to make sure our machines are as robust and durable as can be. Our materials and structures undergo stringent testing for strength and resilience in the most extreme conditions.

### RESILIENT CHAIN FOR 34 TON CLASS RELIABILITY

The DX300LC-3 and Dx340LC-3 are fitted with the same super-strong chain. The 21.6 cm link pitch, 4.5 cm pin diameter and heavy-duty running gear are ideally suited for long, trouble-free service in the roughest conditions

- Track chains: the sealed and lubricated track chains are specifically designed for better pin and bushing retention. Exclusive heat treatment gives the links a consistent surface and strong core hardness, enhancing their durability
- Track guards: two guards per track frame (standard) protect against track derailment. For extra reassurance, two dual-type track guards per track frame or full length track guards are available as options



#### Strengthened boom

Finite Element Analysis (FEA) has been used to calculate the best load distribution throughout the boom structure. Combined with increased material thickness, this means that element fatigue is limited and both reliability and component life are increased.

#### Arm assembly

Cast elements and reinforcements have been added to give the arm assembly greater strength and a longer lifetime. The arm centre and end boss have been strengthened and reinforced bars added to better protect the base of the arm.

#### Protected hydraulics

The hydraulic line routing is straight and simple for a neat, compact design that enhances its durability. The gap between the pipe flange and rubber cushion has been reduced to minimise slack.



#### Extra-strong X-chassis

The X-shaped undercarriage has been designed using Finite Element Analysis and 3D computer simulation to ensure optimum structural integrity and durability. The swing gear is solid and stable.



#### Heavy-duty sprocket

The sprocket is deep induction hardened and the depth pattern on the entire tooth profile is optimised for long-lasting service. Cast steel sprockets guarantee the highest resistance and durability even in the most severe applications. The sprocket tooth shape has been redesigned to prevent popping and increase component life.

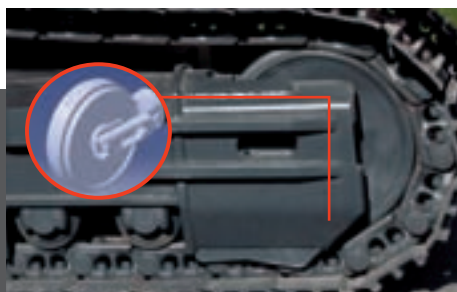

#### Integrated track spring and idler

The track spring and idler have been joined together for long-lasting performance and convenient maintenance. A new seal and cylinder body rod have been used to avoid leakage. Special heat treatment ensures optimum hardness and long-lasting resistance to wear.

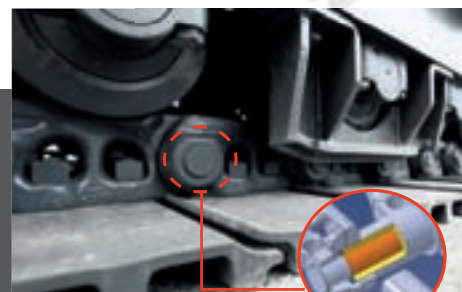

#### Tracks

For long-term dependability in all conditions, the chain is composed of sealed, self-lubricating links which are isolated from all external contamination. The tracks are locked by mechanically bolted pins. In areas subjected to great stress, the track link thickness has been reinforced.



The heavy-duty undercarriage provides excellent stability and durability. It is designed to excel in tough working environments.



**Extra strong sintered bushings**

A highly lubricated metal is used for the boom pivot to increase the component lifetime and extend the greasing intervals. The bucket pivot features EM (Enhanced Macrosurface) bushings. These feature a tailored surface pattern and self-lubricating coating for optimised greasing and more efficient evacuation of debris.

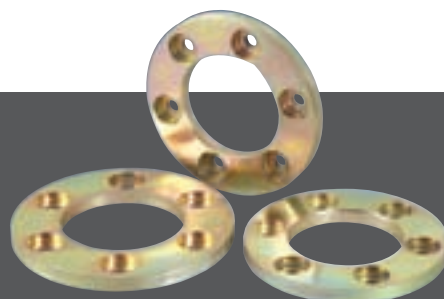

**Ultra hard wear-resistant discs**

New materials have been used to enhance resistance to wear and to extend service intervals. Wear plates on the inside and the outside of the bucket lugs greatly increase disc lifetime.



**Polymer shim**

A polymer shim is added to the bucket pivot to maintain precise control over the equipment and extend greasing intervals.

# More value – less maintenance

Short maintenance operations at long intervals mean you can depend on your equipment being available on site when it's needed. The DX300LC-3 and DX340LC-3 are designed for simple routine maintenance, while skilled Doosan technicians are available to provide extra support when you need it. You can choose the package you need from a broad range of service agreements to get the most out of your machine. Uptime, productivity and residual value are all maximised, making these excavators an economical and rewarding choice.



## Maintenance access made simple

- Large handrails are installed along with anti-slip steps and plates, for safer, easier access to the engine compartment
- The cab's air conditioning filter is lockable and placed on the side of the cab for easy access
- A battery cut-off switch makes it easy to disconnect the battery during long-term storage
- The hour meter display can be easily checked from ground level
- Cock valves have been fitted on the pre-filter piping line and fuel tank drain piping to make servicing easier and prevent pollution from leakage



## Access to components

- Engine parts can be easily reached via the top and side panels
- The radiator and oil cooler have been separated for easier cleaning



- For extra accessibility and servicing convenience, all filters (engine oil filter, fuel pre-filter, fuel filter and pilot filter) are located in the pump compartment

## Air filter with Turbo III

The large capacity forced air cleaner removes over 99 % of airborne particles, while the Turbo III pre-cleaning system uses centrifugal force to eliminate dust. An oil-washed air cleaner is also available as an option.

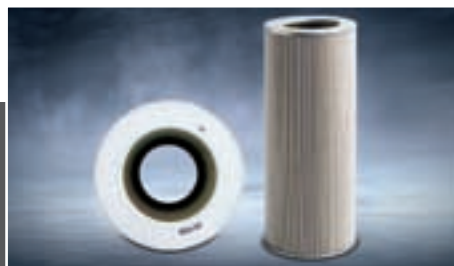

## Protective oil return filter

The protection of the hydraulic system is made more effective by the use of glass fibre technology in the main oil return filter. With more than 99.5 % of foreign particles filtered out, the oil change interval is extended.



## Engine oil filter

The engine oil filter offers a high level of filtration allowing a long interval between changes. It is easy to access and is positioned to avoid contaminating the surrounding environment.



## Fuel pre-filter with water separator sensor

High efficiency fuel filtration is attained by the use of multiple filters. These include a fuel pre-filter fitted with a water separator that removes moisture, dirt and debris from the fuel. A warning sensor is added to each fuel filter to indicate when water draining is required.

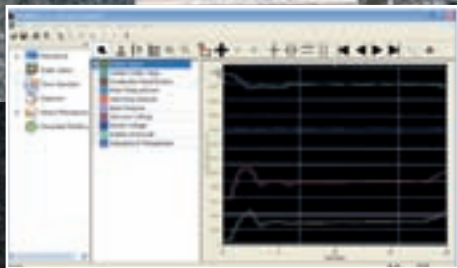

#### PC monitoring

A PC monitoring function enables connection to the e-EPOS system. Thus, various parameters can be checked during maintenance, including pump pressures and engine speed. This information can be saved and printed for analysis.

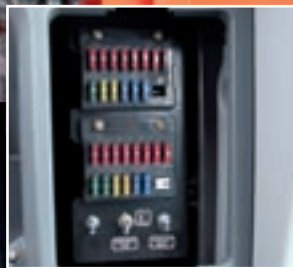

#### Convenient fuse box

The fuse box is located in the storage compartment behind the seat, providing a clean environment and convenient access.



#### DPF regeneration switch

Regeneration is automatic and doesn't interfere with operation. When the level of soot is too high, a warning symbol alerts the operator that he can activate regeneration at any time.

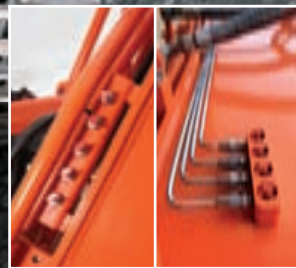

#### Centralised greasing points

To make maintenance easier, the greasing points have been centralised.

# Technical specifications

## \* Engine

<b>• Model</b>	
Doosan DL08K 4-Cycle Water-Cooled, Variable Geometry Turbocharged, Common Rail Direct Injection, Exhaust Gas Recirculation	
<b>• No. of cylinders</b>	
6	
<b>• Rated power at 1800 rpm</b>	<b>DX300LC-3 / DX340LC-3</b>
152 kW (204 PS) / 199 kW (270 PS) (DIN 6271) 159 kW (213 HP) / 210 kW (281 HP) (SAE J1995) 152 kW (201 HP) / 199 kW (266 HP) (SAE J1349)	
<b>• Max. torque at 1300 rpm</b>	<b>DX300LC-3 / DX340LC-3</b>
99 kgf/m (971 Nm) / 130 kgf/m (1275 Nm)	
<b>• Piston displacement</b>	
7640 cm <sup>3</sup>	
<b>• Bore x stroke</b>	
108 mm x 139 mm	
<b>• Starter</b>	
24 V / 6.0 kW	
<b>• Batteries</b>	
2 x 12 V / 150 Ah	
<b>• Air filter</b>	
Double element and pre-filtered Turbo with automatic dust evacuation.	

## \* Weight

DX300LC-3: Boom: 6245 mm • Arm: 3100 mm • GP Bucket: SAE 1.27 m<sup>3</sup> • Counterweight: 5300 kg  
DX340LC-3: Boom: 6500 mm • Arm: 3200 mm • GP Bucket: SAE 1.49 m<sup>3</sup> • Counterweight: 7100 kg

	Shoe width (mm)	Operating weight (kg)	Ground pressure (kgf/cm <sup>2</sup> )
Triple grouser DX300LC-3 / DX340LC-3	600 (std)	30000 / 34900	0.57 / 0.66
	700	30400 / 35300	0.50 / 0.58
	800	30800 / 35600	0.44 / 0.50
	850	30900 / 35800	0.41 / 0.48
	900	- / 36000	- / 0.46
Double grouser DX300LC-3	600	30500	0.58

## \* Undercarriage

Very robust construction throughout. All welded structures designed to limit stresses. High-quality, durable materials. Lateral chassis welded and rigidly attached to undercarriage. Track rollers lubricated for life. Idlers and sprockets fitted with floating seals. Track shoes made of induction-hardened alloy with triple grouser. Heat-treated connecting pins. Hydraulic track adjuster with shock-absorbing tension mechanism.

<b>• Number of rollers and track shoes per side</b>	
Upper rollers (standard shoe):	2
Lower rollers:	9
Number of links & shoes per side:	48
Overall track length:	4940 mm

## \* Hydraulic system

The brain of the excavator is the e-EPOS (Electronic Power Optimizing System). It allows the efficiency of the hydraulic system to be optimised for all working conditions and minimises fuel consumption. The e-EPOS is connected to the engine's electronic control unit (ECU) via a data transfer link to harmonise the operation of the engine and hydraulics.

- The hydraulic system enables independent or combined operations
- Two travel speeds offer either increased torque or high speed
- Cross-sensing pump system for fuel savings
- Auto deceleration system
- Four operating modes, four power modes
- Button control of flow in auxiliary hydraulic circuits
- Computer-aided pump flow control
- Closed center MCV with electro-hydraulic pump control (DX340LC-3)

<b>• Main pumps</b>	<b>DX300LC-3 / DX340LC-3</b>
Tandem, axial piston	
Max. flow:	2 x 248 l/min / 2 x 360 l/min
Displacement:	138 cm <sup>3</sup> /rev. / 200 cm <sup>3</sup> /rev.
Weight:	130 kg / 180 kg
<b>• Pilot pump</b>	<b>DX300LC-3 / DX340LC-3</b>
Gear pump – max. flow: 28.5 l/min / 24.1 l/min	
Displacement:	15 cm <sup>3</sup> /rev. / 10.8 cm <sup>3</sup> /rev.
Relief valve pressure:	40 kgf/cm <sup>2</sup> / 40.8 kgf/cm <sup>2</sup>
<b>• Maximum system pressure</b>	
Boom/arm/bucket	
Work/travel:	350 kg/cm <sup>2</sup> [+10/0]
Rotation:	295 kg/cm <sup>2</sup> [+10/0]
Power:	370 kg/cm <sup>2</sup> [+10/0]

## \* Hydraulic cylinders

Piston rods and cylinder bodies of high-strength steel. Shock-absorbing mechanism fitted in all cylinders for shock-free operation and extended piston life.

Cylinders	Quantity	Bore x rod diameter x stroke (mm) DX300LC-3 / DX340LC-3
Boom	2	140 x 95 x 1450 / 150 x 100 x 1450
Arm	1	150x 105 x 1670 / 170 x 120 x 1805
Bucket	1	135 x 90 x 1150 / 150 x 100 x 1300
SLR Bucket	1	95 x 65 x 900
Arti boom	1	170 x 115 x 1341 / 180 x 110 x 1300



## \* Swing mechanism

- High-torque, axial piston motor with planetary reduction gear bathed in oil
- Swing circle: single-row, shear type ball bearing with induction-hardened internal gear
- Internal gear and pinion immersed in lubricant
- DX300LC-3: max. swing speed: 0 to 9.9 rpm  
DX340LC-3: max. swing speed: 0 to 10.0 rpm
- DX300LC-3: max. swing torque: 12137 kgf/m  
DX340LC-3: max. swing torque: 14573 kgf/m

## \* Drive

Each track is driven by an independent, high-torque axial piston motor through a planetary reduction gearbox. Two levers / foot pedals guarantee smooth travel with counter-rotation on demand.

<b>• Travel speed (low-high)</b>	<b>DX300LC-3 / DX340LC-3</b>
	3.0 - 5.3 km/h / 3.4 / 5.7 km/h
<b>Maximum traction (high - low)</b>	<b>DX300LC-3 / DX340LC-3</b>
	(Eff. = 85-75%) 29.7 - 14.5 ton / 32.2 - 17.4 ton
<b>• Maximum gradeability</b>	
	35° / 70 %

## \* Buckets

DX300LC-3 Bucket Type	Capacity (m <sup>3</sup> ) SAE	Width (mm)		Weight (kg)	Boom: 6245 mm Standard track / Narrow track			Arti boom: 6255 mm Standard track / Narrow track			SLR boom: 10000 mm
		With side cutters	Without side cutters		Arm: 2500 mm	Arm: 3100 mm	Arm: 3750 mm	Arm: 2500 mm	Arm: 3100 mm	Arm: 3750 mm	Arm: 7000 mm
GP	0.64	1167	1083	445							B
	0.80	1037	962	860	A / A	A / A	A / A	A / A	A / A	A / A	
	1.03	1247	1172	990	A / A	A / A	A / B	A / A	A / A	A / A	
	1.27	1286	1220	1180	A / A	A / B	A / C	A / A	A / B	A / C	
	1.51	1657	1582	1220	A / C	B / D	C / D	A / B	C / C	C / D	
	1.75	1867	1792	1310	B / D	C / D	D / -	B / C	C / D	D / -	
HD	1.07	1134	1068	1080	A / A	A / A	A / B	A / A	A / A	A / B	
	1.27	1286	1220	1180	A / B	A / C	B / C	A / A	A / B	A / C	
	1.46	1424	1358	1250	A / C	B / D	C / D	A / B	C / C	B / D	
Rock	1.16	1167	1083	1180	A / A	A / B	A / C	A / A	A / B	A / C	

DX340LC-3 Bucket Type	Capacity (m <sup>3</sup> ) SAE	Width (mm)		Weight (kg)	Boom: 6500 mm Standard track / Narrow track			Arti boom: 6520 mm Standard track / Narrow track		
		With side cutters	Without side cutters		Arm: 2600 mm	Arm: 3200 mm	Arm: 3950 mm	Arm: 2600 mm	Arm: 3200 mm	Arm: 3950 mm
GP	1.25	1278	1228	1249	A / A	A / A	A / B	A / A	A / A	A / B
	1.49	1460	1410	1344	A / A	A / B	B / C	A / A	A / B	B / C
	1.61	1550	1500	1392	A / A	A / B	B / C	A / A	A / B	C / D
	1.83	1718	1668	1522	A / B	B / C	C / D	B / C	B / C	C / D
HD	1.20	1134	1068	1290	A / A	A / A	A / A	A / A	A / A	A / B
	1.42	1286	1220	1414	A / A	A / A	B / C	A / A	A / B	B / C
	1.65	1438	1372	1512	A / B	B / C	C / D	A / B	B / C	C / D
	1.79	1526	1460	1596	A / B	B / C	C / D	B / C	B / C	D / -
	2.01	1676	1610	1692	B / C	C / D	D / -	B / C	C / D	D / -
Rock	1.28	-	1382	1427	A / A	A / A	A / B	A / A	A / A	A / B

Based on ISO 10567 and SAE J296, arm length without quick-coupler. For reference only.

A: Suitable for materials with a density less than or equal to 2100 kg/m<sup>3</sup> / B: Suitable for materials with a density less than or equal to 1800 kg/m<sup>3</sup>

C: Suitable for materials with a density less than or equal to 1500 kg/m<sup>3</sup> / D: Suitable for materials with a density less than or equal to 1200 kg/m<sup>3</sup> / - : Not recommended

## \* Digging forces (ISO)

DX300LC-3 Shoe: 600 mm (SLR: 800 mm)		Boom: 6.245 m Arm: 3.10 m Bucket: 1.27 m <sup>3</sup>	Boom: 6.245 m Arm: 2.50 m Bucket: 1.51 m <sup>3</sup>	Boom: 6.245 m Arm: 3.75 m Bucket: 1.03 m <sup>3</sup>	SLR boom: 10 m Arm: 7.00 m Bucket: 0.64 m <sup>3</sup>	Arti Boom: 6.25 m Arm: 3.10 m Bucket: 1.27 m <sup>3</sup>	Arti Boom: 6.25 m Arm: 2.50 m Bucket: 1.51 m <sup>3</sup>	Arti Boom: 6.25 m Arm: 3.75 m Bucket: 1.03 m <sup>3</sup>
BUCKET (Normal/Press. Up)	ton	18.9 / 20.0	18.9 / 20.0	18.9 / 20.0	10.0 / 10.5	16.9 / 18.0	16.9 / 18.0	16.9 / 18.0
	kN	185.3 / 196.1	185.3 / 196.1	185.3 / 196.1	98.1 / 102.9	165.7 / 176.5	165.7 / 176.5	165.7 / 176.5
ARM (Normal/Press. Up)	ton	13.2 / 13.9	16.0 / 17.0	11.7 / 12.4	7.1 / 7.5	13.2 / 13.9	16.0 / 17.0	11.7 / 12.4
	kN	129.4 / 136.3	156.9 / 166.7	114.7 / 121.6	69.6 / 73.5	129.4 / 136.3	156.9 / 166.7	114.7 / 121.6

DX340LC-3 Shoe: 600 mm		Boom: 6.5 m Arm: 3.20 m Bucket: 1.49 m <sup>3</sup>	Boom: 6.5 m Arm: 2.60 m Bucket: 1.83 m <sup>3</sup>	Boom: 6.5 m Arm: 3.95 m Bucket: 1.25 m <sup>3</sup>	Arti Boom: 6.52 m Arm: 3.20 m Bucket: 1.49 m <sup>3</sup>	Arti Boom: 6.52 m Arm: 2.60 m Bucket: 1.83 m <sup>3</sup>	Arti Boom: 6.52 m Arm: 3.95 m Bucket: 1.25 m <sup>3</sup>
BUCKET (Normal/Press. Up)	ton	24.4 / 25.9	24.4 / 25.9	24.4 / 25.9	24.4 / 25.9	24.4 / 25.9	24.4 / 25.9
	kN	239.3 / 254.0	239.3 / 254.0	239.3 / 254.0	239.3 / 254.0	239.3 / 254.0	239.3 / 254.0
ARM (Normal/Press. Up)	ton	17.9 / 18.9	22.0 / 23.3	15.1 / 16.0	17.9 / 18.9	22.0 / 23.3	15.1 / 16.0
	kN	175.5 / 185.3	215.7 / 228.5	148.1 / 156.9	175.5 / 185.3	215.7 / 228.5	148.1 / 156.9

## \* Fluid capacities

<b>• Fuel tank</b>	<b>DX300LC-3 / DX340LC-3</b>
	500 l / 600 l
<b>• Cooling system (radiator capacity)</b>	<b>DX300LC-3 / DX340LC-3</b>
	50 l / 52 l
<b>• Hydraulic oil tank</b>	<b>DX300LC-3 / DX340LC-3</b>
System (tank full):	280 l / 380 l
<b>• Engine oil</b>	
	36 l
<b>• Swing drive</b>	
	6 l
<b>• Travel device</b>	
	2 x 7 l

## \* Environment

Noise levels comply with environmental regulations (dynamic values).

<b>• Noise level LwA</b>	<b>DX300LC-3 / DX340LC-3</b>
Guaranteed:	103 dB(A) / 104 dB(A)
Measured:	102 dB(A) / 102 dB(A) (2000/14/EC)
<b>• Operator LpA</b>	
	71 dB(A) (ISO 6396)

# Dimensions

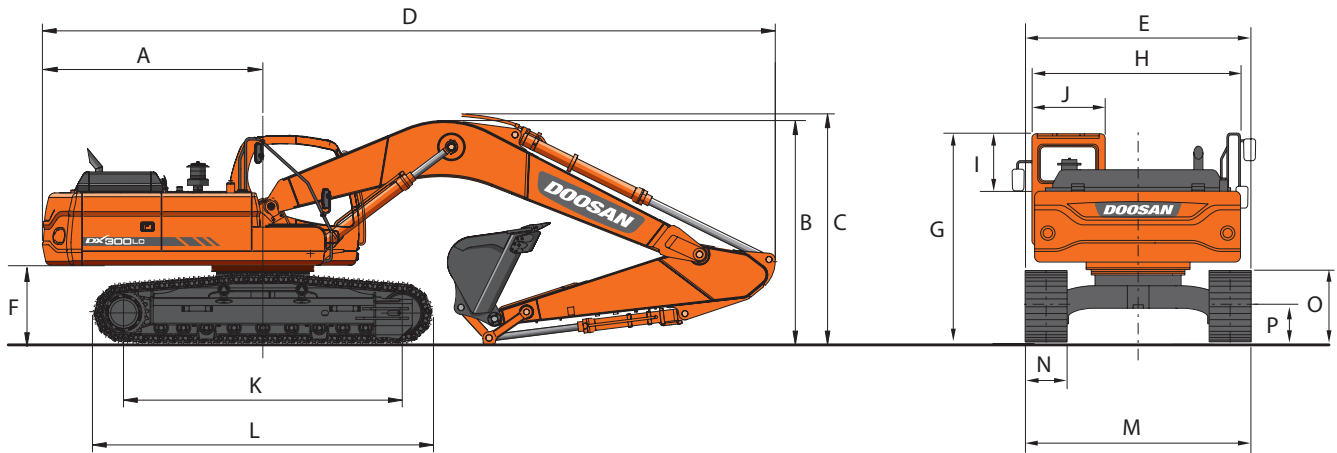

## \* Dimensions mono and articulated boom

	DX300LC-3							DX340LC-3					
	Mono: 6245			SLR: 10000	Arti: 3245 + 3050			Mono: 6500			Arti: 3440 + 3100		
Boom length - mm													
Arm length - mm	3100	2500	3750	7000	3100	2500	3750	3200	2600	3950	3200	2600	3950
Bucket capacity - m <sup>3</sup>	1.27	1.51	1.03	0.64	1.27	1.51	1.03	1.49	1.83	1.25	1.49	1.83	1.25
A Tail swing radius - mm	3200	3200	3200	3200	3200	3200	3200	3500	3500	3500	3500	3500	3500
B Shipping height (boom) - mm	3265	3385	3455	3365	3465	3455	3700	3225	3495	3420	3505	3465	3860
C Shipping height (hose) - mm	3370	3495	3575	3475	3465	3455	3700	3390	3640	3550	3555	3515	3910
D Shipping length - mm	10540	10720	10650	14290	10630	10760	10650	11280	11380	11300	11315	11315	11250
E Shipping width std. - mm	3200	3200	3200	3200	3200	3200	3200	3280	3280	3280	3280	3280	3280
E Shipping width narrow - mm	3000	3000	3000	3000	3000	3000	3000	3000	3000	3000	3000	3000	3000
F Counterweight clearance - mm	1150	1150	1150	1155	1150	1150	1150	1195	1195	1195	1195	1195	1195
G Height over cab - mm	3065	3065	3065	3070	3065	3065	3065	3125	3125	3125	3125	3125	3125
H House width - mm	2960	2960	2960	2960	2960	2960	2960	2990	2990	2990	2990	2990	2990
I Cab height above house - mm	845	845	845	845	845	845	845	845	845	845	845	845	845
J Cab width - mm	1010	1010	1010	1010	1010	1010	1010	1010	1010	1010	1010	1010	1010
K Tumbler distance - mm	4040	4040	4040	4040	4040	4040	4040	4040	4040	4040	4040	4040	4040
L Track length - mm	4940	4940	4940	4940	4940	4940	4940	4940	4940	4940	4940	4940	4940
M Undercarriage width std. - mm	3200	3200	3200	3200	3200	3200	3200	3280	3280	3280	3280	3280	3280
M Undercarriage width narrow - mm	3000	3000	3000	-	3000	3000	3000	3000	3000	3000	3000	3000	3000
N Shoe width - mm	600	600	600	800	600	600	600	600	600	600	600	600	600
O Track height - mm	1048	1048	1048	1058	1048	1048	1048	1048	1048	1048	1048	1048	1048
P Ground clearance - mm	500	500	500	505	500	500	500	510	510	510	510	510	510

## \* Component weights

Item	unit	DX300LC-3	DX340LC-3	Remarks
Upper structure without front	kg	13240	15040	with counterweight
Counterweight std. / SLR	kg	5300 / 6300	7100 / -	
Lower structure assembly	kg	10740	11760	
Front assembly	kg	6000	7280	
Boom	kg	2310 (6245 mm)	2697 (6500 mm)	including bushing
Arm	kg	1050 (3100 mm)	1251 (3200 mm)	including bushing
Bucket	kg	1120 (1.27 m <sup>3</sup> )	1385 (1.49 m <sup>3</sup> )	
Boom cylinder (each)	kg	260	287	
Arm cylinder	kg	335	437	
Bucket cylinder	kg	215	266	
Boom (10000 mm - SLR)	kg	3035	-	
Articulated boom	kg	2510	3062	
Articulated boom cylinder	kg	370	477	
Lower structure assembly	kg	10660	11640	3m narrow track

# Working range

DX300LC-3

DX340LC-3

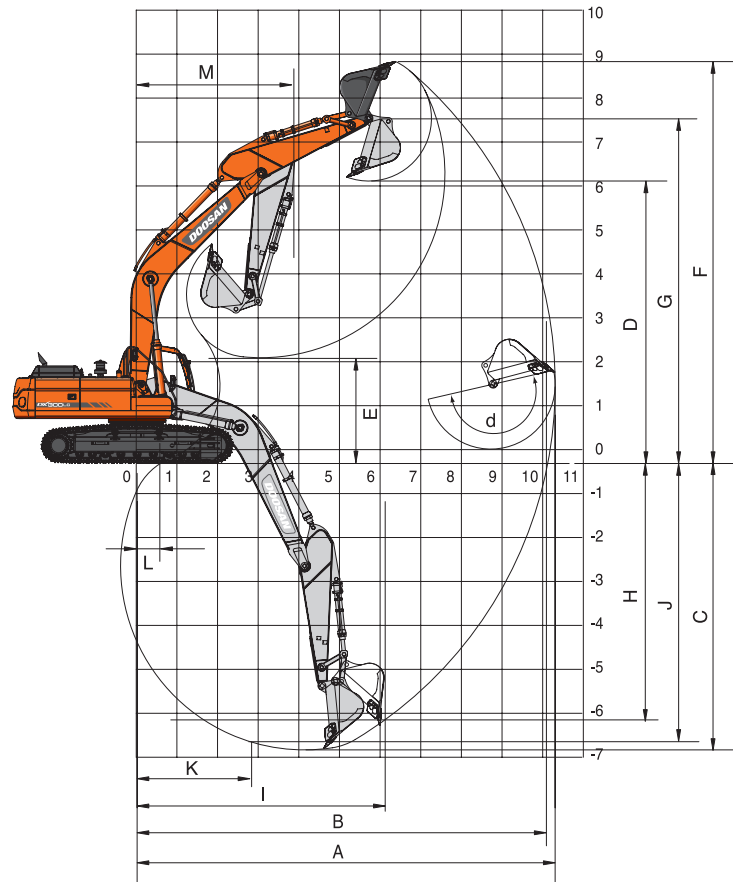

## \* Working range mono and articulated boom

	DX300LC-3							DX340LC-3					
	Mono: 6245			SLR: 10000	Arti: 3250 + 3050			Mono: 6500			Arti: 3440 + 3100		
Boom length - mm													
Arm length - mm	3100	2500	3750	7000	3100	2500	3750	3200	2600	3950	3200	2600	3950
Bucket capacity - m <sup>3</sup>	1.27	1.51	1.03	0.64	1.27	1.51	1.03	1.49	1.83	1.25	1.49	1.83	1.25
A Max. digging reach - mm	10725	10155	11240	17510	10860	11280	11415	11170	10585	11930	11380	10770	12150
B Max. digging reach (ground) - mm	10530	9950	11065	17390	10670	10075	11235	10970	10380	11745	11185	10565	11975
C Max. digging depth - mm	7305	6700	7950	13780	7010	6510	7605	7535	6935	8290	7350	6740	8135
D Max. loading height - mm	7280	6990	7395	11975	8895	8415	9255	7175	6865	7635	9065	8560	9900
E Min. loading height - mm	2055	3360	2110	1450	3540	4260	2920	2710	3315	1955	3645	4385	3005
F Max. digging height - mm	10325	10010	10405	14195	12085	11615	12450	10320	9970	10815	12455	11925	13305
G Max. bucket pin height - mm	8880	8585	8990	13290	10495	7970	10855	8880	8570	9340	10765	10245	11605
H Max. vertical wall depth - mm	6125	5395	6600	11590	6650	5915	7135	5890	5090	6830	5935	5250	6750
I Max. radius vertical - mm	6840	6840	7070	10900	6330	6360	6580	7720	7715	7785	7550	7510	7680
J Max. digging depth (8° level) - mm	7110	6465	7755	13395	6905	6295	7515	7345	6720	8155	7170	6540	7970
K Min. radius 8° line - mm	3000	2970	2920	4140	1800	1825	1820	3320	3270	3395	2395	2430	2380
L Min. digging reach - mm	510	1925	-340	785	1155	2300	-1980	710	2175	-349	1780	2745	1005
M Min. swing radius - mm	4040	4045	4050	6120	2820	3015	3015	4455	4480	4515	3440	3635	3510
d Bucket angle - °	175	176	174	169	175	176	174	178	178	178	178	178	178



# Lifting capacities

## Standard configuration

Standard track width: 3200 mm • Boom: 6245 mm • Arm: 3100 mm • W/O Bucket • Shoe: 600 mm • Counterweight: 5300 kg

Units: 1000 kg

B (m)	1.5		3.0		4.5		6.0		7.5		9.0		Max. lift		A (m)
7.5													* 5.41	* 5.41	7.27
6.0							* 6.88	* 6.88	* 6.80	5.75			* 5.20	4.92	8.19
4.5					* 9.57	* 9.57	* 8.01	7.94	* 7.28	5.60			* 5.22	4.31	8.77
3.0					* 12.67	11.44	* 9.49	7.49	* 8.04	5.38	* 5.96	4.04	* 5.41	3.99	9.07
1.5					* 15.24	10.65	* 10.91	7.08	8.31	5.16	6.30	3.94	* 5.79	3.87	9.10
0 (Ground)					* 16.49	10.28	11.41	6.82	8.13	5.00			6.34	3.94	8.89
-1.5	* 8.59	* 8.59	* 12.25	* 12.25	* 16.64	10.19	11.27	6.70	8.05	4.93			6.85	4.24	8.40
-3.0	* 13.98	* 13.98	* 18.94	* 18.94	* 15.88	10.28	11.31	6.73	8.12	4.99			7.99	4.92	7.59
-4.5			* 19.28	* 19.28	* 13.89	10.56	* 10.23	6.95					* 9.46	6.49	6.32

## Option 1

Standard track width: 3200 mm • Boom: 6245 mm • Arm: 2500 mm • W/O Bucket • Shoe: 800 mm • Counterweight: 5300 kg

Units: 1000 kg

B (m)	3.0		4.5		6.0		7.5		Max. lift		A (m)
7.5					* 7.40	* 7.40			* 7.60	7.31	6.55
6.0					* 7.73	* 7.73	* 7.61	5.80	* 7.63	5.70	7.57
4.5			* 10.92	* 10.92	* 8.81	7.99	* 7.91	5.68	7.74	4.92	8.19
3.0			* 14.01	11.39	* 10.21	7.57	* 8.57	5.48	7.18	4.53	8.50
1.5			* 16.14	10.76	* 11.47	7.21	8.51	5.30	7.02	4.40	8.54
0 (Ground)			* 16.79	10.55	11.70	7.01	8.38	5.18	7.24	4.51	8.31
-1.5	* 12.52	* 12.52	* 16.48	10.56	11.64	6.95	8.36	5.16	7.94	4.92	7.79
-3.0	* 20.82	* 20.82	* 15.29	10.72	* 11.56	7.05			9.56	5.87	6.90
-4.5	* 16.94	* 16.94	* 12.55	11.09					* 10.05	8.39	5.46

## Option 2

Standard track width: 3200 mm • Boom: 6245 mm • Arm: 3750 mm • W/O Bucket • Shoe: 850 mm • Counterweight: 5300 kg

Units: 1000 kg

B (m)	1.5		3.0		4.5		6.0		7.5		9.0		Max. lift		A (m)
7.5									* 5.64	* 5.64			* 4.48	* 4.48	7.92
6.0									* 6.03	6.03			* 4.36	* 4.36	8.78
4.5							* 7.12	* 7.12	* 6.61	5.84	* 5.69	4.31	* 4.39	4.05	9.32
3.0					* 11.21	* 11.21	* 8.67	7.84	* 7.45	5.59	6.65	4.19	* 4.57	3.77	9.60
1.5					* 14.11	11.17	* 10.23	7.37	* 8.34	5.34	6.51	4.06	* 4.90	3.65	9.63
0 (Ground)			* 8.56	* 8.56	* 15.91	10.62	* 11.43	7.03	8.37	5.14	6.39	3.96	* 5.44	3.70	9.43
-1.5	* 8.53	* 8.53	* 12.26	* 12.26	* 16.56	10.42	11.57	6.85	8.24	5.02			* 6.35	3.93	8.97
-3.0	* 12.59	* 12.59	* 17.19	* 17.19	* 16.26	10.43	11.54	6.82	8.23	5.01			7.25	4.46	8.21
-4.5	* 17.56	* 17.56	* 21.26	* 21.26	* 14.89	10.62	* 11.10	6.95					* 9.01	5.60	7.05
-6.0			* 16.38	* 16.38	* 11.59	11.08							* 9.66	8.85	5.24

## Option Arti 1

Narrow track width: 3000 mm • Articulated Boom: 3245 mm LB + 3050 mm UB • Arm: 3100 mm • W/O Bucket • Shoe: 600 mm • Counterweight: 5900 kg

Units: 1000 kg

B (m)	3.0		4.5		6.0		7.5		9.0		Max. lift		A (m)
9.0					6.10 *	6.10 *					6.01 *	6.01 *	6.02
7.5					8.33 *	7.59					5.31 *	5.20	7.43
6.0			8.71 *	8.71 *	9.11 *	7.41	8.15 *	5.13			5.03 *	4.21	8.35
4.5			12.90 *	10.89	10.25 *	7.03	8.48 *	4.97			4.97 *	3.69	8.92
3.0			15.16 *	9.86	11.27 *	6.57	8.98	4.74	6.74	3.55	5.07 *	3.42	9.20
1.5			16.46 *	9.09	12.01 *	6.16	8.73	4.52	6.63	3.46	5.34 *	3.32	9.24
0 (Ground)			16.28 *	8.75	11.98	5.90	8.55	4.37	6.24 *	3.40	5.83 *	3.39	9.03
-1.5	11.06 *	11.06 *	14.93 *	8.69	11.45 *	5.81	8.48	4.31			6.68 *	3.65	8.55
-3.0	15.30 *	15.30 *	12.52 *	8.82	9.77 *	5.86	7.09 *	4.39			6.46 *	4.24	7.75

## Option Arti 2

Standard track width: 3200 mm • Articulated Boom: 3245 mm LB + 3050 mm UB • Arm: 3750 mm • W/O Bucket • Shoe: 800 mm • Counterweight: 5900 kg

Units: 1000 kg

B (m)	3.0		4.5		6.0		7.5		9.0		Max. lift		A (m)
10.5			6.34 *	6.34 *							5.59 *	5.59 *	4.83
9.0					6.17 *	6.17 *					4.53 *	4.53 *	6.86
7.5					6.49 *	6.49 *	5.73 *	5.73 *			4.12 *	4.12 *	8.12
6.0					6.89 *	6.89 *	6.69 *	6.31			3.95 *	3.95 *	8.96
4.5	9.29 *	9.29 *	8.91 *	8.91 *	8.51 *	8.51 *	7.50 *	6.11	5.81 *	4.51	3.93 *	3.93 *	9.49
3.0			13.22 *	12.63	9.99 *	8.19	8.04 *	5.85	6.44 *	4.39	4.03 *	3.83	9.76
1.5			14.90 *	11.64	10.87 *	7.70	8.68 *	5.58	6.69 *	4.26	4.25 *	3.73	9.80
0 (Ground)			15.32 *	11.08	11.25 *	7.35	8.76	5.38	6.70	4.15	4.64 *	3.79	9.60
-1.5	10.63 *	10.63 *	14.57 *	10.89	10.94 *	7.17	8.53 *	5.27	6.53 *	4.12	5.28 *	4.04	9.15
-3.0	15.40 *	15.40 *	12.78 *	10.94	9.80 *	7.16	7.47 *	5.28			5.94 *	4.57	8.40
-4.5			9.74 *	9.74 *	7.45 *	7.33					5.15 *	5.15 *	7.28

## Option Narrow

Narrow track width: 3000 mm • Boom: 6245 mm • Arm: 3100 mm • W/O Bucket • Shoe: 600 mm • Counterweight: 5300 kg

Units: 1000 kg

B (m)	1.5		3.0		4.5		6.0		7.5		9.0		Max. lift		A (m)	
7.5														* 5.41	5.16	7.27
6.0							* 6.88	* 6.88	* 6.80	4.87				* 5.20	4.15	8.19
4.5					* 9.57	* 9.57	* 8.01	6.69	* 7.28	4.72				* 5.22	3.61	8.77
3.0					* 12.67	9.41	* 9.49	6.26	* 8.04	4.51	* 5.96	3.37		* 5.41	3.33	9.07
1.5					* 15.24	8.67	* 10.91	5.87	8.29	4.30	6.29	3.28		* 5.79	3.22	9.10
0 (Ground)					* 16.49	8.32	11.38	5.61	8.11	4.14				6.33	3.27	8.89
-1.5	* 8.59	* 8.59	* 12.25	* 12.25	* 16.64	8.24	11.25	5.50	8.03	4.07				6.84	3.51	8.40
-3.0	* 13.98	* 13.98	* 18.94	16.04	* 15.88	8.33	11.29	5.53	8.10	4.13				7.97	4.08	7.59
-4.5			* 19.28	16.52	* 13.89	8.59	* 10.23	5.74						* 9.46	5.38	6.32

## Option Narrow 2

Narrow track width: 3000 mm • Boom: 6245 mm • Arm: 2500 mm • W/O Bucket • Shoe: 600 mm • Counterweight: 5300 kg

Units: 1000 kg

B (m)	3.0		4.5		6.0		7.5		Max. lift		A (m)
7.5					* 7.40	7.06			* 7.60	6.08	6.54
6.0					* 7.73	6.92	* 7.61	4.79	* 7.63	4.72	7.56
4.5			* 10.90	10.07	* 8.81	6.58	* 7.91	4.68	7.54	4.04	8.19
3.0			* 13.99	9.13	* 10.21	6.18	8.50	4.49	6.99	3.70	8.50
1.5			* 16.14	8.54	* 11.47	5.83	8.29	4.31	6.83	3.58	8.54
0 (Ground)			* 16.79	8.34	11.39	5.64	8.15	4.19	7.04	3.65	8.31
-1.5	* 12.48	* 12.48	* 16.49	8.35	11.33	5.58	8.13	4.17	7.72	3.98	7.79
-3.0	* 20.84	16.41	* 15.29	8.50	11.44	5.67			9.62	4.76	6.90
-4.5	* 16.96	16.94	* 12.57	8.85					* 10.05	6.76	5.47

## Option SLR

Standard track width: 3200 mm • Boom: 10000 mm • Arm: 7000 mm • W/O Bucket • Shoe: 800 mm • Counterweight: 6300 kg

Units: 1000 kg

B (m)	1.5		3.0		4.5		6.0		7.5		9.0		10.5		12.0		13.5		15.0		Max. lift		A (m)					
12.0																						1.47 *	1.47 *	12.85				
10.5																	1.88 *	1.88 *				1.41 *	1.41 *	13.90				
9.0																	2.58 *	2.58 *				1.38 *	1.38 *	14.71				
7.5																2.81 *	2.81 *	2.81 *	2.57	1.84 *	1.84 *	1.37 *	1.37 *	15.34				
6.0																3.02 *	3.02 *	2.95 *	2.48	2.42 *	1.98	1.38 *	1.38 *	15.80				
4.5																3.83 *	3.83 *	3.50 *	3.50 *	3.28 *	2.95	3.12 *	2.37	2.84 *	1.91	1.41 *	1.41 *	16.10
3.0					9.36 *	9.36 *	6.56 *	6.56 *	5.20 *	5.20 *	4.41 *	4.38	3.91 *	3.46	3.56 *	2.77	3.33 *	2.25	3.10	1.83	1.46 *	1.46 *	16.26					
1.5					6.44 *	6.44 *	7.93 *	6.83	6.07 *	5.13	5.00 *	4.00	4.32 *	3.20	3.86 *	2.60	3.55 *	2.13	3.01	1.75	1.52 *	1.47	16.28					
0 (Ground)			3.28 *	3.28 *	5.76 *	5.76 *	8.99 *	6.16	6.82 *	4.67	5.53 *	3.68	4.71 *	2.97	4.12	2.43	3.46	2.01	2.93	1.67	1.62 *	1.45	16.16					
-1.5	3.85 *	3.85 *	4.35 *	4.35 *	6.22 *	6.22 *	9.69 *	5.76	7.39 *	4.34	5.94	3.43	4.80	2.79	3.98	2.30	3.36	1.92	2.87	1.61	1.74 *	1.46	15.90					
-3.0	4.82 *	4.82 *	5.43 *	5.43 *	7.09 *	7.09 *	10.08 *	5.57	7.41	4.15	5.75	3.27	4.66	2.66	3.87	2.20	3.28	1.85	2.83	1.57	1.91 *	1.50	15.49					
-4.5	5.85 *	5.85 *	6.58 *	6.58 *	8.22 *	8.22 *	10.22 *	5.51	7.31	4.05	5.65	3.17	4.58	2.58	3.81	2.14	3.25	1.82			2.14 *	1.58	14.91					
-6.0	6.93 *	6.93 *	7.81 *	7.81 *	9.58 *	8.60	10.14 *	5.55	7.30	4.04	5.63	3.15	4.55	2.56	3.80	2.13	3.26	1.83			2.47 *	1.72	14.15					
-7.5	8.11 *	8.11 *	9.19 *	9.19 *	11.21 *	8.84	9.83 *	5.67	7.38	4.11	5.67	3.19	4.59	2.59	3.85	2.18					2.97 *	1.95	13.18					
-9.0	9.41 *	9.41 *	10.78 *	10.78 *	11.98 *	9.18	9.25 *	5.88	7.46 *	4.25	5.79	3.30	4.70	2.69							3.83 *	2.31	11.94					
-10.5			12.68 *	12.68 *	10.60 *	9.64	8.29 *	6.19	6.72 *	4.49	5.52 *	3.51									4.56 *	2.96	10.33					
-12.0					8.48 *	8.48 *	6.70 *	6.65	5.34 *	4.87												4.78 *	4.38	8.16				

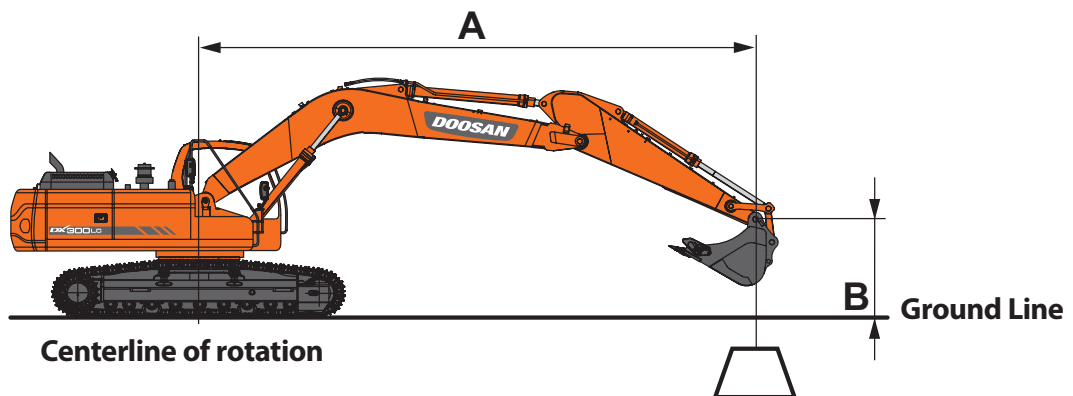

- Lifting capacities are in compliance with ISO 10567.
- The load point is at the end of the arm.
- \* = The nominal loads are based on hydraulic capacity.
- The nominal loads shown do not exceed 75 % of tipping loads or 87 % of hydraulic lifting capacity.
- Weight of all lifting accessories must be deducted from or added to the above lifting capacities.
- The configurations indicated do not necessarily reflect the standard equipment of the machine.

: Rating over front  
 : Rating over side or 360°

## Standard configuration

Standard track width: 3280 mm • Boom: 6500 mm • Arm: 3200 mm • W/O Bucket • Shoe: 600 mm • Counterweight: 7100 kg

Units: 1000 kg

A (m) \ B (m)	1.5		3.0		4.5		6.0		7.5		9.0		Max. lift		A (m)	
7.5										* 8.12	7.46			* 7.79	7.06	7.73
6.0										* 8.25	7.38			* 7.60	5.82	8.60
4.5					* 12.65	* 12.65	* 10.15	10.1	* 8.89	7.14	7.92	5.30		* 7.68	5.15	9.15
3.0					* 16.12	14.45	* 11.80	9.49	* 9.74	6.84	7.77	5.17		7.23	4.80	9.42
1.5					* 18.58	13.48	* 13.23	8.97	10.02	6.55	7.62	5.02		7.08	4.67	9.45
0 (Ground)					* 19.37	13.08	13.72	8.64	9.79	6.35	7.51	4.92		7.25	4.75	9.23
-1.5			* 14.99	* 14.99	* 18.97	13.01	13.57	8.51	9.69	6.25				7.80	5.10	8.75
-3.0	* 17.82	* 17.82	* 23.40	* 23.40	* 17.57	13.15	* 13.36	8.56	9.75	6.31				8.99	5.85	7.96
-4.5			* 19.80	* 19.80	* 14.87	13.49	* 11.25	8.80						* 9.52	7.55	6.73

## Option 1

Standard track width: 3280 mm • Boom: 6500 mm • Arm: 2600 mm • W/O Bucket • Shoe: 600 mm • Counterweight: 7100 kg

Units: 1000 kg

A (m) \ B (m)	1.5		3.0		4.5		6.0		7.5		9.0		Max. lift		A (m)	
7.5														* 9.06	8.24	7.00
6.0							* 9.70	* 9.70	* 9.00	7.28				* 8.94	6.58	7.95
4.5					* 14.17	* 14.17	* 11.01	9.93	* 9.52	7.07				8.57	5.74	8.54
3.0							* 12.55	9.37	* 10.26	6.80				7.99	5.31	8.83
1.5							* 13.76	8.92	10.01	6.55				7.82	5.17	8.86
0 (Ground)					* 19.38	13.13	13.74	8.67	9.83	6.39				8.05	5.29	8.63
-1.5					* 18.48	13.18	13.67	8.61	9.79	6.36				8.78	5.75	8.11
-3.0			* 21.46	* 21.46	* 16.64	13.39	* 12.84	8.73						* 10.15	6.78	7.25
-4.5			* 16.82	* 16.82	* 13.24	* 13.24								* 9.95	9.35	5.88

## Option 2

Standard track width: 3280 mm • Boom: 6500 mm • Arm: 3200 mm • W/O Bucket • Shoe: 800 mm • Counterweight: 7100 kg

Units: 1000 kg

A (m) \ B (m)	1.5		3.0		4.5		6.0		7.5		9.0		Max. lift		A (m)	
7.5									* 8.12	7.58				* 7.79	7.18	7.73
6.0									* 8.25	7.50				* 7.60	5.93	8.60
4.5					* 12.65	* 12.65	* 10.15	* 10.15	* 8.89	7.26	8.07	5.40		* 7.68	5.25	9.15
3.0					* 16.12	14.69	* 11.80	9.65	* 9.74	6.96	7.93	5.26		7.37	4.89	9.42
1.5					* 18.58	13.72	* 13.23	9.13	10.21	6.67	7.77	5.12		7.22	4.76	9.45
0 (Ground)					* 19.37	13.32	13.99	8.81	9.98	6.47	7.66	5.02		7.39	4.85	9.23
-1.5			* 14.99	* 14.99	* 18.97	13.25	13.84	8.67	9.88	6.37				7.95	5.20	8.75
-3.0	* 17.83	* 17.83	* 23.40	* 23.40	* 17.57	13.39	* 13.36	8.72	9.94	6.43				9.16	5.96	7.96
-4.5			* 19.80	* 19.80	* 14.87	13.73	* 11.25	8.96						* 9.52	7.69	6.73

## Option Narrow 1

Narrow track width: 3000 mm • Arm: 3200 mm • W/O Bucket • Shoe: 600 mm • Counterweight: 7100 kg

Units: 1000 kg

A (m) \ B (m)	1.5		3.0		4.5		6.0		7.5		9.0		Max. lift		A (m)	
7.5									* 8.12	6.70				* 7.79	6.34	7.73
6.0									* 8.25	6.62				* 7.60	5.21	8.60
4.5					* 12.65	* 12.65	* 10.15	9.01	* 8.89	6.39	7.89	4.73		7.68	4.59	9.15
3.0					* 16.12	12.67	* 11.80	8.43	* 9.74	6.09	7.74	4.60		7.20	4.26	9.42
1.5					* 18.58	11.74	* 13.23	7.93	9.98	5.81	7.59	4.46		7.05	4.14	9.45
0 (Ground)					* 19.37	11.36	13.67	7.61	9.75	5.61	7.48	4.36		7.22	4.21	9.23
-1.5			* 14.99	* 14.99	* 18.97	11.30	13.52	7.48	9.65	5.52				7.77	4.51	8.75
-3.0	* 17.83	* 17.83	* 23.40	22.63	* 17.57	11.43	* 13.36	7.52	9.71	5.57				8.95	5.18	7.96
-4.5			* 19.80	* 19.80	* 14.87	11.76	* 11.25	7.76						* 9.52	6.68	6.73

## Option Arti 2

Narrow track width: 3000 mm • Arm: 2600 mm • W/O Bucket • Shoe: 600 mm • Counterweight: 7100 kg

Units: 1000 kg

A (m) \ B (m)	1.5		3.0		4.5		6.0		7.5		9.0		Max. lift		A (m)	
7.5														* 9.06	7.40	7.00
6.0							* 9.70	9.34	* 9.00	6.52				* 8.94	5.89	7.95
4.5					* 14.17	13.55	* 11.01	8.86	* 9.52	6.32				8.54	5.12	8.54
3.0							* 12.55	8.31	10.25	6.06				7.96	4.73	8.83
1.5							* 13.76	7.87	9.97	5.82				7.79	4.59	8.86
0 (Ground)					* 19.38	11.42	13.69	7.63	9.80	5.66				8.02	4.69	8.63
-1.5					* 18.48	11.46	13.62	7.58	9.76	5.62				8.75	5.10	8.11
-3.0			* 21.46	* 21.46	* 16.64	11.66	* 12.84	7.69						* 10.15	6.01	7.25
-4.5			* 16.82	* 16.82	* 13.24	12.08								* 9.95	8.27	5.88

# Standard and optional equipment

DX300LC-3  
DX340LC-3

## \* Standard equipment

Hydraulic system
Boom and arm flow regeneration
Swing anti-rebound valves
Spare ports (valve)
One-touch power boost
Breaker piping
Cylinder cushioning & contamination seals
Cab & Interior
Roll Over Protective Structure (ROPS)
Pressurised, sound-insulated and CabSus mounted cab
Heated, adjustable air suspension seat with adjustable headrest and armrest
Jog shuttle switch
Air conditioning with climate control
Pull-up type front window with sun roller blind and removable lower front window
Ceiling light
Intermittent upper windshield wiper
Multiple storage compartments (e.g. document holder under seat)
Rain visor
Flat, spacious, easy-to-clean floor
Cigarette lighter and ashtray
Cup holder
Anti-theft protection
Hot and cool box
Fuel control dial
7" (18 cm) LCD colour monitor panel
Engine speed (RPM) control dial
Speed regulator (auto-idle)
Automatic rear window defroster
4 operating modes & 4 working modes
Control of auxiliary hydraulic flow
Remote radio ON/OFF switch
12 V spare power socket
Serial communication port for laptop PC interface
Adjustable PPC wrist control levers for arm, boom, bucket and swing, with sliding proportional control for attachments and auxiliary hydraulic buttons
USB port
DPF regeneration switch
Sliding left front and rear windows with lock
Tool storage area
Travel pedals and hand levers
Master key
Safety
Boom and arm cylinder safety valves
Overload warning device
Large handrails and step
Rotating beacon
Rear view camera
Punched metal anti-slip plates
Hydraulic safety lock lever
Safety glass
Hammer for emergency escape
Right and left rearview mirrors
Emergency engine stop
Reinforced cast steel pivot points
Lockable fuel cap and covers
Battery cut-off switch
Halogen work lights (2 front frame, 4 front cab-mounted, 2 rear cab-mounted, 2 boom-mounted and 1 rear side)
Other
Mono boom DX300LC-3: 6.245 m – arm: 3.1 m / DX340LC-3: 6.50 m – arm: 3.20 m
Counterweight DX300LC-3: 5300 kg / DX340LC-3: 7100 kg
DOOSAN DL08K turbocharged, Common Rail direct injection, EU Stage IIIB compliant Diesel engine combined with e-EPOS System
Auto shut-off fuel filler pump
Double element air cleaner
Fuel pre-filter with water separator sensor
Dry type pre-cleaner
Diesel particulate filter
Dust screen for radiator/oil cooler
Engine overheat prevention system
Engine restart prevention system
Self-diagnostic function
Alternator (12 V, 80 A)
Electric horn
Toolkit and spare parts for first service
Hydrostatic 2-speed travel system with automatic shift
Remote greasing for swing circle and workgroup pivot points
Attachment management system
Pilot control pattern change
Guards for work lights
Undercarriage
Hydraulic track adjuster
Normal track guards
Greased and sealed track links
600 mm triple grouser shoe

## \* Optional equipment

Cab & Interior
MP3/USB radio with CD player
Safety
FOGS cab - top and front cab guards (ISO 10262)
Front window upper and lower guards
Side view camera
Other
Articulated boom DX300LC-3: 6.30 m with 3.10 m arm / Dx340LC-3: 6.50 with 3.20 arm
Arms DX300LC-3: 2.50 m, 3.75 m (SLR: boom 10 m and arm 7 m) / Dx340LC-3: 2.60 m, 3.95 m
Counterweight DX300LC-3: 5900 kg for articulated & 6300 kg for SLR / Dx340LC-3: 7100 kg
Heavy-duty bottom cover
Doosan buckets: all range of GP, HD & Rock buckets
Doosan breaker: DXB260H and Doosan quick-couplers
Hydraulic piping for crusher, quick coupler, clamshell, tilting and rotating buckets
Additional filter for breaker piping
Floating boom function
Wiper for lower front window
Double pump flow
Water separator with heater
Engine coolant heater
Oil-washed air cleaner
Straight travel pedal
Telescopic rotating beacon
Full length track guard
Dual-type track guard
Bio oil
Centralised greasing
Undercarriage
Narrow undercarriage 3.00 m
600 mm double grouser shoe
700, 800 & 850 mm triple grouser shoe (+ 900 mm for DX340LC-3)

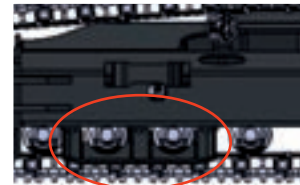

### Dual-type track guard

A newly designed dual guiding track guard is available to maintain track alignment.



### Diesel heater

Improves start-up ability in extremely cold conditions by heating coolant and fuel.



### Straight travel pedal

Allows more operator comfort when multi-tasking.



### Oil-washed air cleaner

Increases cleaning of the air intake in extra dusty areas such as quarries.



### Doosan buckets

A range of dependable new Doosan buckets is available to cover several applications.



### Doosan breakers and quick-couplers

Doosan provides the tough, reliable equipment you need for demolition work.

# Doosan Infracore

## The pulse of transformation



Construction Equipment

Machine Tools

Engines

The spirit of challenge and innovation has led Doosan. We started out as a small store in Seoul in 1896 and have expanded into a global company. Today we are engaged in the infrastructure support business (ISB), which encompasses industrial facilities, machinery, heavy equipment and construction. You can also see the Doosan brand in various other industries.

You are invited to take a closer look at the new world that is being built by Doosan, visit us at: [www.doosaninfracore.com](http://www.doosaninfracore.com) and [www.doosanequipment.eu](http://www.doosanequipment.eu)

## Doosan Infracore Construction Equipment

### A partner you can trust



Finance  
your  
ambitions



[www.doosanequipment.eu](http://www.doosanequipment.eu)

### Financial Solutions

Doosan Infracore Financial Services (DI FS) is specialised in creating financing solutions to meet a wide variety of needs. Contact your local dealer for more information.

### Always a dealer near you

Our well-developed dealer network has the knowledge and experience to take the best care of our Doosan customers. No matter where you are, you'll get the service you expect - and can rely on!

### Parts & Service

- Complete parts & service support for all Doosan products
- Highest quality genuine parts
- Large, dedicated staff of factory-trained aftermarket professionals in the field



[www.doosanequipment.eu](http://www.doosanequipment.eu)